

cozziaTM



INSTRUCTION MANUAL EC-618B

Thank you for purchasing the EC-618B Massage chair.
Before using your massage chair, please read the contents of this instruction manual and refer to it when needed.

Table of Contents

| | |
|-----------------------------------|-------|
| Luxury Features | 1 |
| Safety Precautions | 2-6 |
| Chair Components | 7-8 |
| Chair Installation & Moving | 9-14 |
| Chair Remote Controller | 15 |
| Operation Guide | 16-21 |
| Grounding Instructions | 22 |
| Chair Specifications | 23 |
| Troubleshooting | 24 |
| Product Care and Storage | 25 |
| Warranty Information | 26-28 |
| Warranty Card (Attachment) | |

01 Luxury Features

- COZZIA massage Chair is controlled by a microcomputer that performs various intelligent massage type and combinations such as Kneading, Swedish, Tapping, Shiatsu, Clapping, Rolling, Scrapping, Foot Roller, Vibration and Air Massage. All these types performing massage with accurate on the acupressure points, to effectively alleviate fatigue, promote metabolism and improve blood circulation.
- Innovated 3D robot controlled by a microcomputer brings fire-new precise and thorough massage enjoyment, especially focusing on the acupressure points of the back.
- S-track backrest well accordant with the curve of human back make massage much effective and comfortable.
- 8 set of Auto massage programs and various type of manual massage function are able to meet various requirement in publics.
- Full body air squeezing massage located in neck, shoulder, arm, back, seat and leg.
- Luxurious and shining head cover with functions of speakers for surrounding music and various LED light to creat most relaxing and comfortable massage environment.
- Unique and effective roller massage at soles.
- Additional lumbar heating and vibration function in the center of seat.
- Auto scanning and manual fine adjustment to customize the height of back massage.
- The angel of backrest and legrest can be adjusted simultaneously and separately, backrest from 115 degree to 160 degree, while the Footrest from 0 degree to 90 degree, and zero-gravity position available by one-touch.
- The Timer is adjustable according to your desired duration of the massage programmer.
- Liquid Crystal Display for a user friendly operation even in the dark.
- Designed with power surge protector as well as automatic thermal sensor and auto shutdown for safety.
- The operation is controlled by intelligent microprocessor for excellent performance and consistent quality.
- Ergonomically designed to enhance massage experience.

02 Safety Precautions

IMPORTANT SAFETY INSTRUCTIONS

When using the massage chair, basic precautions should always be followed, including the following:

Read all instructions before using this massage chair.

DANGER-To reduce the risk of electric shock:

- Always unplug this massage chair from the electrical outlet immediately after using and before cleaning.
- Never use pins or other metallic fasteners with this appliance.
- Carefully examine the covering before each use. Call for service if the covering shows any sign of deterioration, such as blistering, peeling or cracking.
- Keep dry-Do not operate in a wet or moist condition.

WARNING- To reduce the risk of burns, fire, electric shock or injury to persons:

- Read all instructions before using.
- A massage chair should never be left unattended when plugged in. Unplug from the outlet when it is not in use and before putting on or taking off parts.
- Close supervision is necessary when this massage chair is used by or near children or disabled persons. Keep children away from reclining backrest and extended leg rest.
- Use this massager chair only for its intent use as described in this manual.
- Never operate this massage if it has a damaged cord or plug, if it is not working properly, if it has been dropped or damaged, or dropped into water. Contact Customer Department.
- Keep the cord away from heated surfaces.
- Never operate the massage chair with the air openings blocked. Keep the air openings free of lint, hair, and the like.
- Never drop or insert any object into any opening.
- Do not use outdoors.
- Do not operate where aerosol (spray) products are being used or where oxygen is being administered.

-
- To disconnect, turn all controls to the off position, then remove the plug from the outlet.
 - Do not stand on or in the massage chair. Use only while seated.
 - The product is not intended for use by children or persons with reduced physical, sensory or mental capabilities, or lack of experience and knowledge, unless they have been given supervision or instruction concerning use of the product by a person responsible for their safety.

Safety

- Children should be supervised to ensure that they do not play with the product.
- Temperatures sufficiently high to cause burns may occur regardless of the control setting. Do not use on an infant or invalid or on a sleeping or unconscious person. Check the skin in contact with the heated area of the appliance frequently to reduce the risk of blistering.
- Burns may result from improper use
- Do not crush-avoid sharp folds.
- Keep children away from extended foot support (or other similar parts).
- DO NOT WET-DO NOT USE PINS.
- NEVER REMOVE COVER.
- Connect this appliance to a properly grounded outlet only. See Grounding Instructions.

SAVE THESE INSTRUCTIONS

This massage chair is intended for household use only.

1. Usage Environment

- Do not use the massage chair in an excessively humid or dusty environment as this may result in malfunction or electric shock.
- Do not use the massage chair in a room with a temperature of 104°F or higher.
- Do not expose the massage chair to heaters, stoves or direct sunlight.
- Place and use the massage chair on an even, non-slip floor.
- The massage chair is designed for home use and not for commercial purposes.

 **Caution**

- This massage chair is to be used indoors only.
- If you use the massage chair in a cold room, do not increase the room temperature abruptly. It is recommended that you increase the temperature gradually to a normal level.
- If the massage chair is stored in a cold place and is being brought into a warm environment, it is advisable to wait one hour before use. This is because its performance may not be at optimum level, as there may be water droplets on the mechanical parts due to condensation. Using the massage chair under such conditions may result in malfunction.

2. Safety Precautions

- To ensure safe and correct use of the massage chair, do not operate it without reading this operation manual carefully.
- Do not use the massage chair when the upholstery or seat is removed. This may cause injury or malfunction.
- Do not use the massage in combination with other therapeutic equipment or electric blanket, etc, as this may result in ineffectiveness or injury.
- Do not use the massage chair an hour before or after eating as this may have adverse effects on the user.
- Do not allow children or pets to play around the massage chair, e.g. behind the backrest, under the seat or leg rest of the massage chair. This may result in injury.
- Do not use the massage chair when your body is wet.
- Do not operate the massage chair with wet hands.
- It is not recommended to use the massage for more than 15 minutes.
- Do not perform continuous massage on the same sport of your body for more than 5 minutes at a time as this may result in excessive stimulation and may have adverse effects.
- Do not insert your hand or foot along the paths of the massage rollers during use as this may cause injury.
- Stop operation immediately if you experience any discomfort.
- This product is not intended for self-treatment of conditions that should be managed by a qualified health care provider.
- People on medication or with medical conditions, please consult your doctor before use. Please do not use the product if you are not feeling well.

3. People with Medical Conditions

Consult your doctor before use if you:

- are under medical rest as ordered by a doctor.
- have spinal disorders, an abnormal spinal condition or have suffered a spinal injury.
- have back problems.
- have diabetes, osteoporosis or sensory impairment.
- have joint dysfunction such as rheumatism, hammertoe or gout.
- have a pacemaker or other electronic medical devices.
- may be pregnant.
- have phlebitis or thrombosis.
- have an increased risk for blood clots.
- had recent surgery.
- have surgical pins, screws, or anything mechanical in the legs, ankles or feet.



Caution

- This massage chair is not intended for use by children or persons with reduced physical, sensory or mental capabilities, or lack of experience and knowledge, unless they have been given supervision or instruction or instruction concerning use of the massage chair by a person responsible for their safety.
- Children should be supervised to ensure that they do not play with the massage chair.
- Avoid using the massage chair under the influence of alcohol.
- Do not apply massage rollers directly on the head, elbow or knee joints, torso or abdomen.
- If your legs or feet slip off the leg rest during massage, do not force them back in as this may result in injury.
- Remove the power plug from the electrical outlet immediately should liquid be accidentally spilled onto the massage chair. Do not use wet hands to connect or disconnect the power plug from the electrical outlet.
- Do not tamper with the power cord or use the massage with a damaged cord as this may result in malfunction and electric shock.

4. Instances When the Massage Chair Should Not Be Used

In the following events, please switch off the main power switch immediately and disconnect the power cord from the electrical outlet:

- If water is accidentally spilled onto the massage chair. This may result in electric shock or malfunction.
- If the fabric of the backrest is torn and the internal components are exposed.
- If pain or discomfort is felt during massage, stop operation immediately and consult your doctor.
- If you detect any malfunction or any other abnormal condition during operation.
- If there is a power failure. Injury may occur when power is restored unexpectedly.
- If there is lightning.

5. Assembly and Repair of the Massage Chair

- Do not disassemble the backrest cover of the massage chair. Touching the internal components may result in malfunction or electrical shock.
- This massage chair must only be professionally serviced or repaired. Do not attempt to disassemble or repair the massage chair yourself.

6. Things to Note About the Power Plug and Cord

- Check that the Alternating Current (AC) voltage corresponds with the specifications indicated for the massage chair.
- Do not connect or disconnect the power plug from the electrical outlet with wet hands. This may result in malfunction or electric shock..
- When disconnecting the power plug, pull it by holding the plug, not the cord.
- Although operation will be stopped automatically by the Auto-Timer function, always remember to switch off the main power switch after use.
- Do not place the power cord under the massage chair or any other heavy objects.
- Do not wind the power cord around the massage chair as this may damage the cord and result in a fire or electric shock.
- Do not operate the massage with a damaged cord or extension cord.
- Do not use the massage if the electrical outlet is loose.
- If the power cord is damaged, it should be replaced by a qualified technician.

03 Chair Components

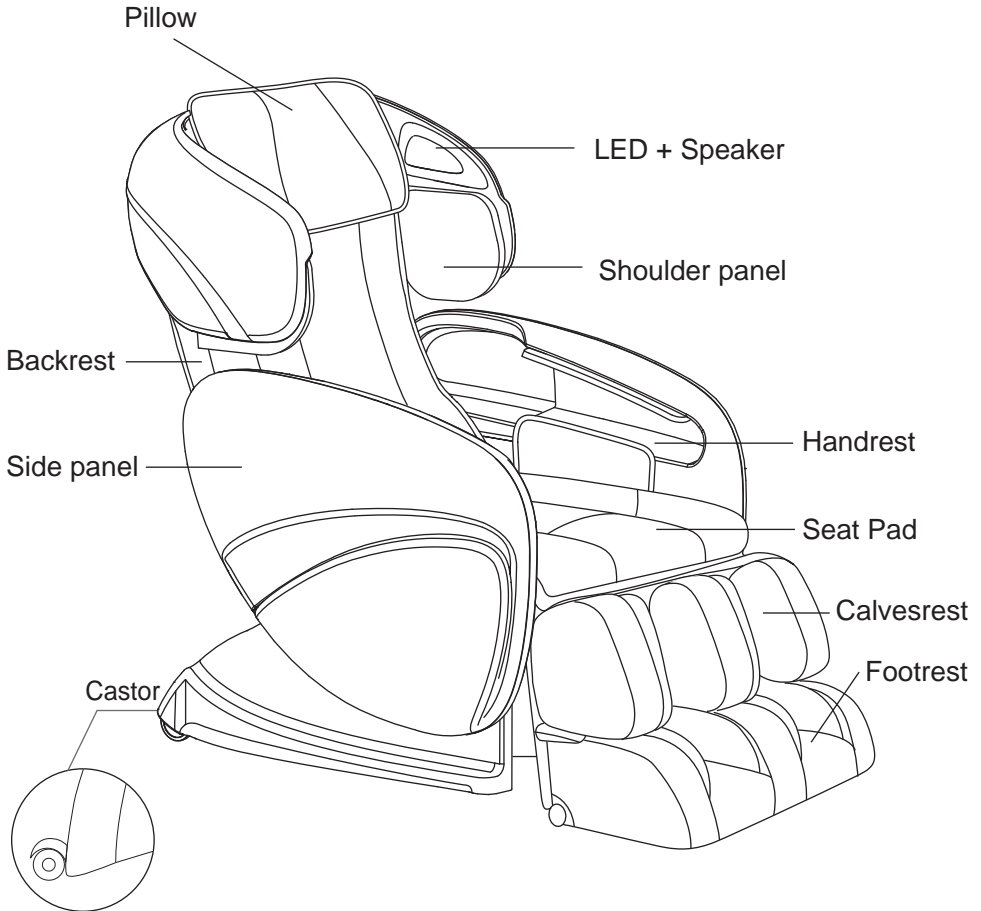

Massaging Position

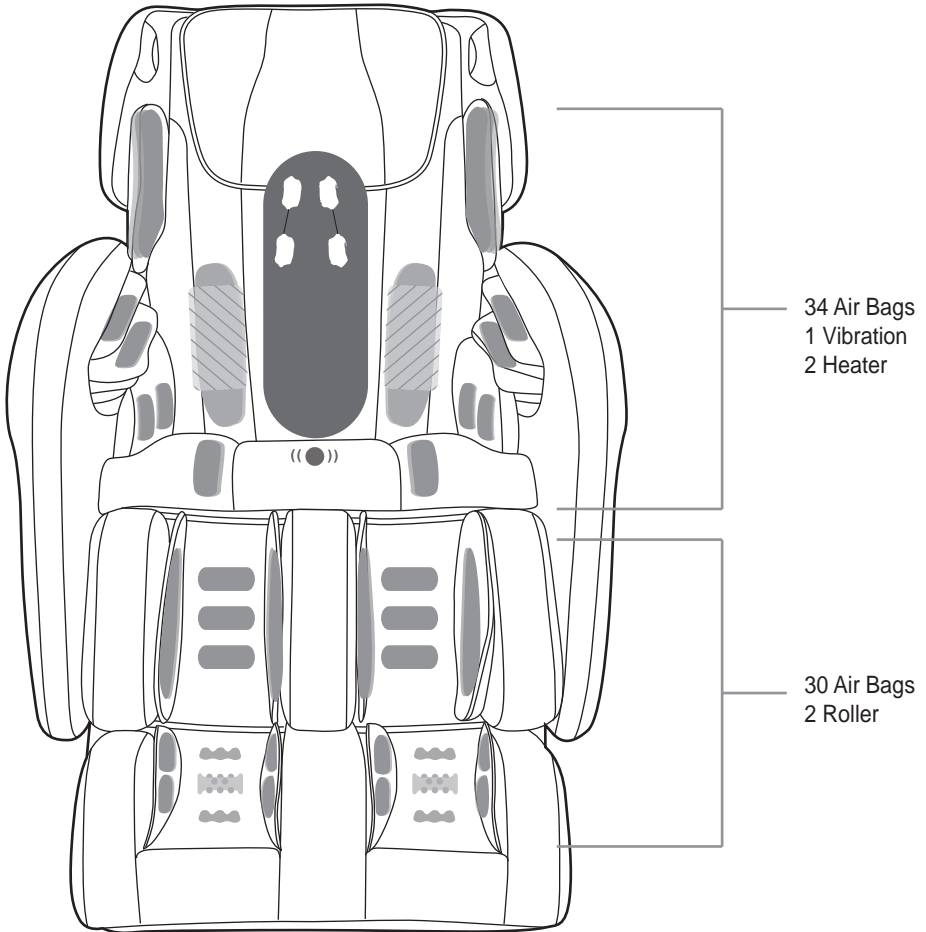

● Back Massage
Mode

⦿ Vibration

● Air Bag

▨ Heater

▨ Roller

04 Chair Installation & Moving

Note: Ensure sufficient spaces around the chair. When backrest reclining and footrest raising, the minimum 80cm space must be ensured both at the front and the back of chair. Bottom of the chair may damage the tatami mattress or floor. It is recommended to spread a piece of mattress under the chair.

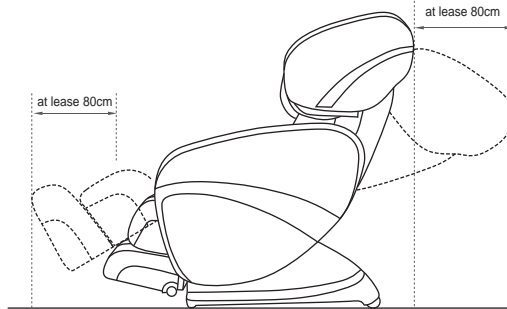

Step 1:

- Use the diagonal pliers to cut off the cable tie which binds the stopper of the backrest, and unwrap the packaging material of the backrest actuator (a) underneath the seat pad and both seat anchor (b).
- Put the backrest pad onto the seat pad which was used to avoid the backrest pad from oil pollution from seat anchor on both side.
- Lift the backrest, and insert part A into part B as shown in picture.

Note: Put remote controller wire out of the side panel which could avoid of wire damage when install the backrest.

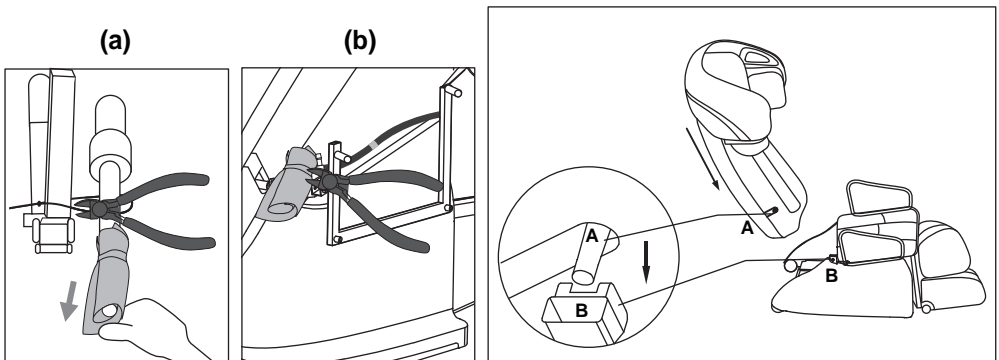

Step 2:

- Turn the backrest to front, it will help expose all the air tubes out from backrest, named group A as picture showing, and remove the spare white plastic stoppers on each air tube.
- Connect well air tubes "A" with corresponding air tube "B" (out from PCB box) as shown in picture. Then stuff all air hoses well connected inside to avoid pressing air tubes whiling chair moving.
- Connect data plug out from backrest into the corresponding socket in the electric control box.
- Raise the backrest.

Note: Please make sure above connection is well done before turning on the chair.

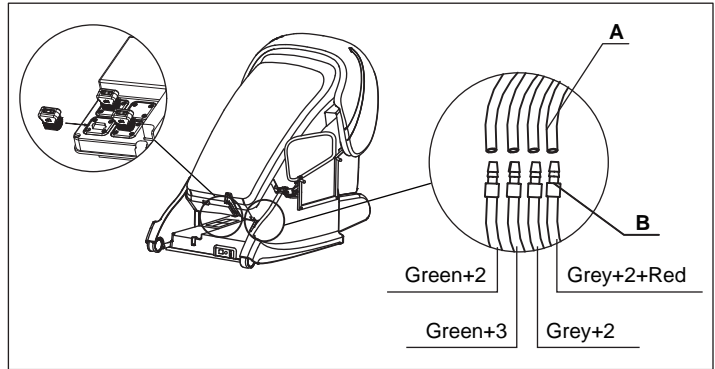

Step 3:

- Take off the bin (flat head rivet) and bolt (split pin) from backrest actuator (a), and put them on the ground.
- Attach the backrest connection rod (A) and the fork (B) with the flat head rivet (C). Lock the rivet with split pin (D) as showed in PIC 1 and PIC 2.
- Turn the backrest to back until a "click" sound is heard.

- A: Connecting rod
B: Fork
C: Flat head rivet
D: Split pin

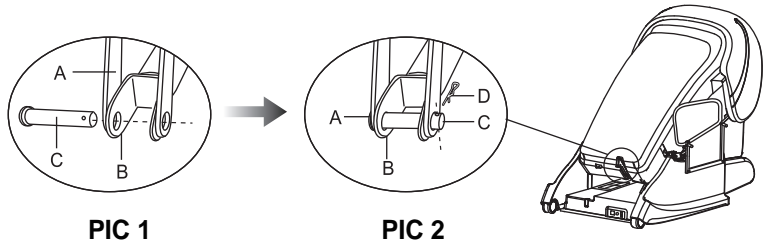

Step 4:

- Attach backrest pad onto backrest with the zipper.
- Align and engage Velcro onto backrest.

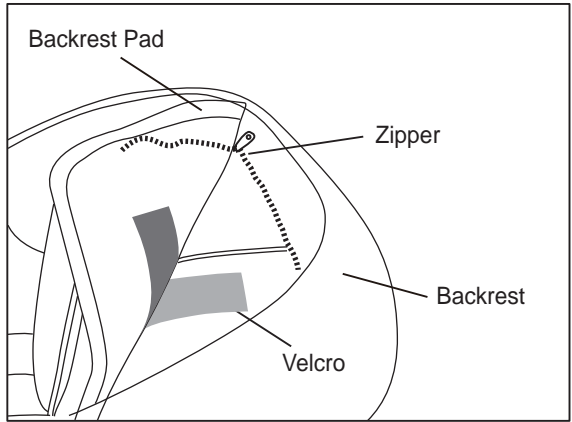

Step 5: Install Side Panel

- 1) Remove side panel cover E by slightly pulling the cloth strip (which could be thrown away after use) from inner side panel.
- 2) Connect air tube(H) out from side panel and the air tube(G) out from underneath of seat, and the air tube(H) must cross the seat frame as picture showing before connecting with air tube(G) to avoid pressing while chair playing.

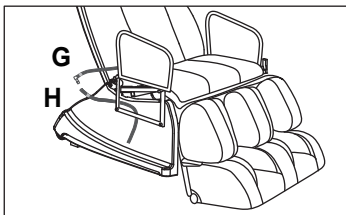
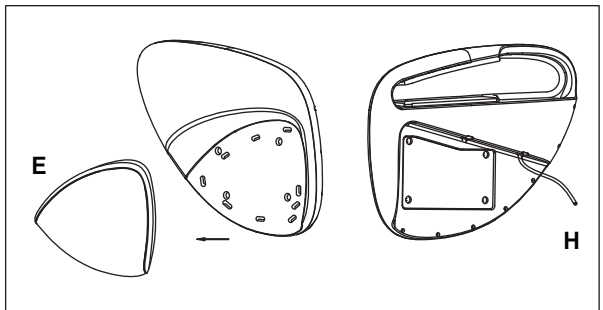
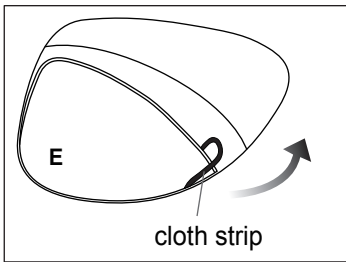

3) Attach side panel to the seat by aiming the 4 screw holes, then fix by the 4 bolts (M6*30).

4) Target the white plastic holes on inner side of side panel to attach side panel cover (E).

Repeat above 1) ~ 4) to assemble the other side.

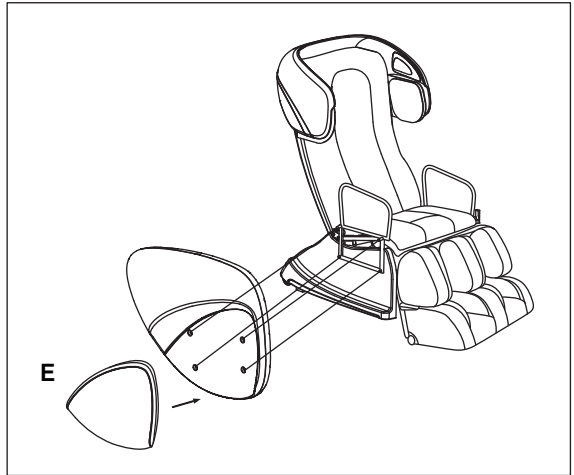

Step 6:

Place controller into pocket.

MP3 could be connected to this wire to get music, and it could be place into the right pocket.

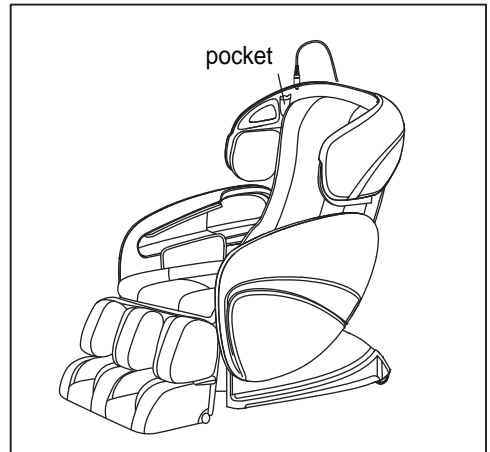
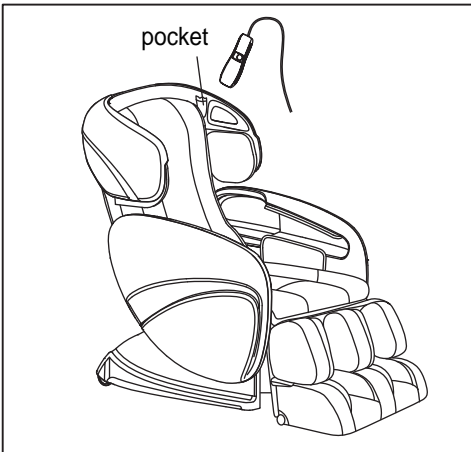

Step 7:

Connect the Power Cord.

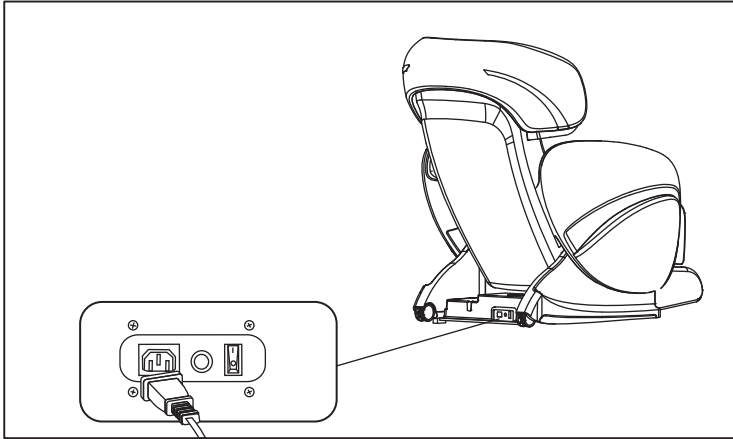
**Step 8:**

The back massage strength-control pad has been inserted into the backseat cover. If strong massage is desired, remove the back massage strength-control pad from the cover; this strengthens the massage. If milder massage are desired, insert the back massage strength-control pad into the cover; this lessens the strength of the massage.

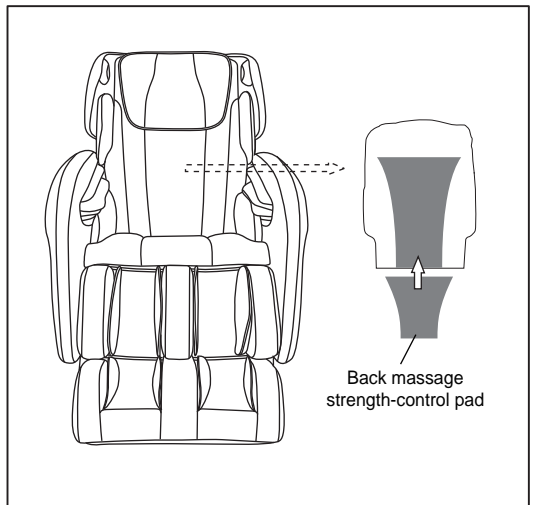

Moving the chair

1. Restore the footrest to its original position.
2. Recline the chair to tilt approximately 45 degrees. Move the chair using the wheels as the fulcrum.

Note:

- Always return the footrest to its original length and restore it to its original position before moving the chair, otherwise injury during movement may result.
- Do not move the chair while a person is seated on it.
- Place a mat on the floor and gently roll the chair over it to avoid damaging the floor.

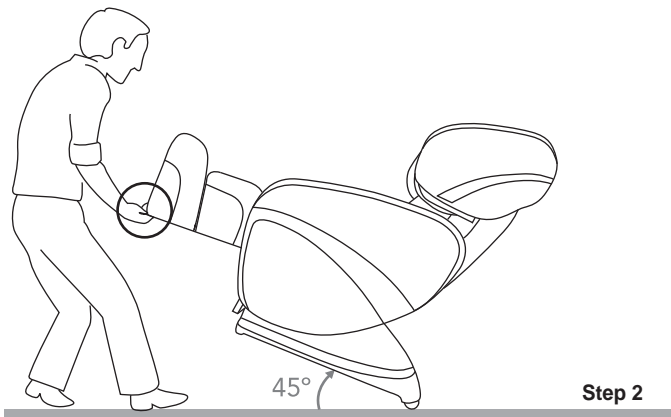
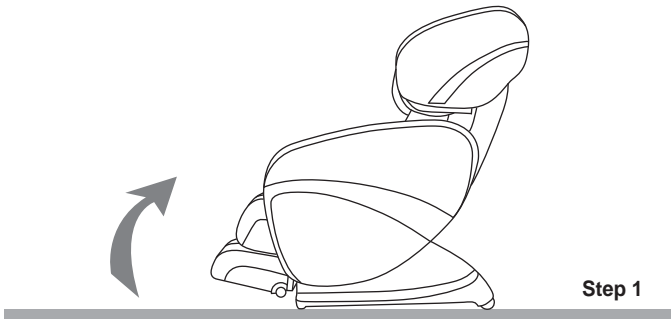

05 Chair Remote Controller

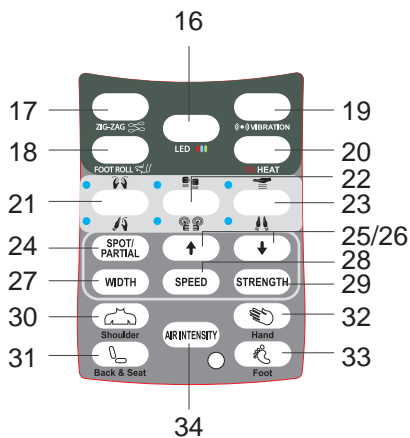

06 Operation Guide

Connect to the power supply, and turn the switch to “I” position, chair is now in idle mode. During its idle mode, ON/OFF button will blink, which means the electric is well connected. During its idle mode, only ON/OFF, Pause, Legrest Recline/Restore, Chair Recline/Restore buttons can be operatable.

Control Buttons for the Massage Chair

1. ON/OFF

The Start/Stop Control Button

Press this button to light ON the LCD screen. Press any massage function button to start massage. This will initiate the timer function. Press this button again to stop all massage functions, massage chair will return to its original position.

2. TIMER

Time interval Control Button

When a massage function is activated, the timer is preset at 15 minutes. Every single press on this button will change the timer interval in the sequence of “20>25>30>5>10>15>20” minutes.

Note: Slumber auto massage program is fixed 20 minutes.

3. PAUSE

Press this button once to halt running massage function and countdown timer. During pause mode, the pause button will be blinking.

Press this button again to cease the “Pause” function and resume previous massage function as well as countdown timer.

4. ZERO-G

Press this button to active the Zero-G function in default,press again to return to idle position.



Note: ZERO-G button is NOT controllable during auto programs of Swedish and Thai.

5. LEGREST RECLINE AND RESTORE

Angle Adjustment Button for Legrest

Keep pressing the either button and release until the legrest reach your ideal position.

6. CHAIR RECLINE AND RESTORE

Keep pressing  to reach lying flat comfortably, while pressing  to restore the chair to its original position.

Full body Auto massage program

7. GENTLE(2D)

8. RELAX (2D)

9. THERAPHY (2D)

10. VIGOROUS (2D)

11. DEMO (2D)

12. SWEDISH (3D)

13. THAI (3D,with stretching function)

14. CHINESE (3D)

15. Legrest Length Adjustment Button

Keep pressing the either button and release until the length of chair legrest fit your leg well.

Note: When Zero-G program is activated 1st time after chair is turn on, the chair will scan and adjust the length of legrest automatically, and memory the customized length for you to save repeated scanning before you end this time enjoyment.

16. LED LIGHTING

LED Lighting Founction Start/Stop Control Button

Press this button to activate LED lighting function at both sides's shoulder. Every single press on this button will change the colors of LED lighting in the sequence of Red > Blue > Green > auto circle of "Red>Blue>Green">Close.

Note: The Auto Program of Gentle, Relax, Therapy and Vigorous, are preset one LED background color, and you can also adjust the LED color by pressing the LED button.

17. ZIG - ZAG

ZIG - ZAG function Start/Stop Control Button

Press this button to activate updated full body twisting massage by air squeezing located in back and seat. Press this button again to stop the ZIG – ZAG function.

18. FOOT ROLLING

Foot roll function Start/Stop Control Button

Press this button once to activate rhythmic rolling massage at soles, press this button again to stop rolling massage at soles.

Note: During Auto Program mode, pressing this button can also disable/enable the Foot Rolling function.

19. VIBRATION

Seat Vibration function Start/Stop Control Button

Press this button once to activate rhythmic seat vibration function, press this button again to stop the Vibration function.

Note: During Auto Program mode, pressing this button can also disable/enable the Vibration function.

20. HEAT

Lumbar Heat function Start/Stop Control Button

Press this button to activate lumbar heat function, press this button again to stop the Heat function.

Note: During Auto Program mode, pressing this button can also disable/enable the Heat function.

Manual Massage Program

21. KNEADING

Kneading function Start/Stop Control Button – 5 levels of strength to be adjusted

Press this button to activate rhythmic mode 1 Kneading function for a full back massage at medium strength. Press the button again to activate mode 2 Kneading function. Press the button for the third time to stop Kneading function and switch to mode 1 Swedish function.

21. SWEDISH

Swedish function Start/Stop Control Button – 5 levels of speed to be adjusted.

When mode 2 Kneading function is engage, press this button to activate rhythmic mode 1 Swedish function for a full back massage at medium speed. Press this button again to activate mode 2 Swedish function. Press once more to stop the Swedish function. To activate Swedish function directly, press this button 3 times during idle mode.

22. TAPPING

Tapping function Start/Stop Control Button - 3 levels of width, 5 levels of speed to be adjusted.

Press this button to activate rhythmic mode 1 Tapping function for a full back massage at medium speed. Press the button again to activate mode 2 Tapping function.

Press the button for the third time to stop Tapping function and switch to mode 1 Shiatsu function.

22. SHIATSU

Shiatsu function Start/Stop Control Button – 3 levels of width, 5 levels of speed to be adjusted.

When mode 2 Tapping function is engage, press this button to activate rhythmic mode 1 Shiatsu function for a full back massage at medium speed. Press this button again to activate mode 2 Shiatsu function. Press once more to stop the Shiatsu function. To activate Shiatsu function directly, press this button 3 times during idle mode.

23. CLAPPING

Clapping function Start/Stop Control Button – 3 levels of width, 5 levels of speed to be adjusted

Press this button to activate rhythmic mode 1 Clapping function for a full back massage at medium speed. Press the button again to activate mode 2 Clapping function.

Press the button for the third time to stop Clapping function and switch to Rolling function.

23. ROLLING

Rolling function Start/Stop Control Button – 3 levels of width to be adjusted

When mode 2 Clapping function is engage, press this button to activate Rolling function for a full back massage. Press this button again to stop the Rolling function. To activate Rolling directly, press this button 3 times during idle mode.

Note: This function cannot perform “Spot” massage function.

24. SPOT/PARTIAL

The Spot or Partial Back massage

Press this button once to activate localize Spot massage while the original massage mode continues to run at the latest position. Press this button again to switch to Partial massage function.

Note: Partial Massage will take the latest position as the center to perform Partial Massage with the distance approx. 8 cm.

25/26. Upward/Downward adjustment

The position adjustment button for spot and partial massage. When the spot and partial massage function are activated, this button can be used to move the massage rollers. Hold this button to move the massage rollers upward/downward respectively. Release the buttons when reaching desired position.

27. WIDTH

The Width Adjustment Button for Tapping, Clapping, Shiatsu and Rolling function

When Tapping, Clapping, Shiatsu or Rolling function is engage, every single press on this button will change the massage width interval in the sequence of “Narrow > Medium > Wide” in cycle.

28. SPEED

The Speed Adjustment Button for Tapping, Clapping, Swedish and Shiatsu function

When Tapping, Clapping, Swedish or Shiatsu function is engage, every single press on this button will change the massage speed interval in the sequence of “Lv1 > Lv2 > Lv3 > Lv4 > Lv5” in cycle.

29. STRENGTH

The Strength Adjustment Button for Kneading function

When Kneading function is engage, every single press on this button will change the massage speed strength interval in the sequence of “Lv1 > Lv2 > Lv3 > Lv4 > Lv5” in cycle.

Setting Air Squeeze

30. SHOULDER

Shoulder Air Squeeze Massage Control Button – 5 levels of intensity to be adjusted
Press this button once to activate rhythmic air massage at shoulder. Press this button again to stop the function.

31. BACK & SEAT

Back and Seat Air Squeeze Massage Control Button – 5 levels of intensity to be adjusted
Press this button once to activate rhythmic air massage at back and seat. Press this button again to stop the function.

32. HAND

Hand Air Squeeze Massage Control Button – 5 levels of intensity to be adjusted
Press this button once to activate rhythmic air pressure massage at Hand Rest. Press this button again to stop the function.

33. FOOT

Footrest Air Squeeze Massage Control Button – 5 levels of intensity to be adjusted
Press this button once to activate rhythmic air pressure massage at Footrest. Press this button again to stop the function.

34. AIR INTENSITY

The Intensity Adjustment Button for Air pressure massage, 5 levels of intensity to be adjusted

When Air massage function is engaged, every single press on this button will change the air intensity in the sequence of “Lv1 > Lv2 > Lv3 > Lv4 > Lv5” in cycle.

Finish Operating

Please press the “ON/OFF” button after use. Massage Rollers will restore to its original position; then switch the power supply button under the chair to “O” and unplug the machine from the wire socket.

07 Grounding Instructions

This product must be grounded. If it should malfunction or break down, grounding provides a path of least resistance for the electric current to reduce the risk of electric shock. This product is equipped with a cord with an equipment-grounding conductor and a grounding plug. The plug must be plugged into an appropriate outlet that is properly installed and grounded in accordance with all local codes and ordinances.

Danger-Improper connection of the equipment-grounding conductor can result in a risk of electric shock. Check with a qualified electrician or service technician if you provided with the product-if it will not fit the outlet, have a proper outlet installed by a qualified electrician.

This product is for use on a nominal 120V circuit and has grounding plug that looks like that plug illustrated below. Make sure that the product is connected to an outlet having the same configuration as the plug. No adapter should be used with this product.

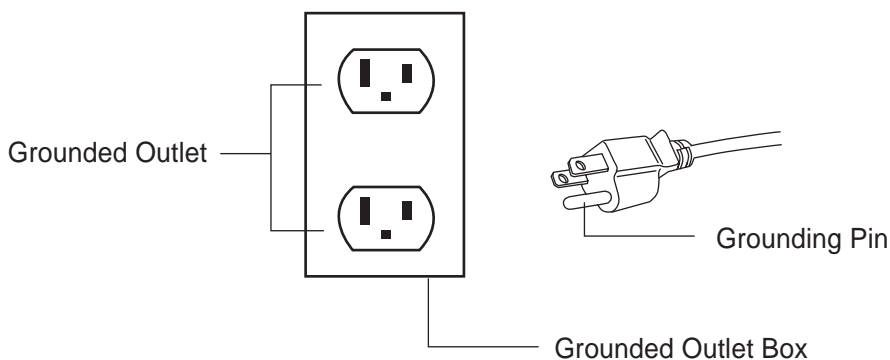

08 CHAIR SPECIFICATIONS

| Product Name | | Ogawa Smart DeLight |
|---------------------------------|---------------|--|
| Model no. | | EC-618B |
| Power source | | 110-120V~ |
| Alternating current | | 50/60Hz |
| Power consumption | | 300W |
| Power of speakers | | 14W (2 sides) |
| Timer | | 5/10/15/20/25/30 minutes |
| Maximum operating period | | 30 minutes |
| Dimension (Length/width/height) | | Seat Part: 52.4" x 30" x 25.8" |
| | | Back Part: 51.6" x 30" x 22.6" |
| | | Side Panel: 28.7" x 13.8" x 39.6" |
| Weight | Net Weight: | Seat Part: 130lbs / BackPart: 95lbs / Side Panel: 44lbs |
| | Gross Weight: | Seat Part: 148lbs / BackPart: 110lbs / Side Panel: 50.8lbs |
| Length of the wire | | Controller wire: Approx 80CM |
| | | Power supply wire: Approx 1.8M |
| | | Music connection wire: Approx 15+75CM |
| Usage condition | | Environment temperature: 10°C-40°C |
| | | Contrasting humidity: 30-85RH |
| Storage condition | | Storage temperature: 20°C-60°C |
| | | Storage humidity level: 30-85RH |
| Safety feature | | Equipped with overheated and power surge safety protection |
| Using benefits | | Increasing blood circulation; Relieving muscular fatigue |

09 Troubleshooting

This massage chair is controlled by a microcomputer and is susceptible to power surges of +10 to -15%.

The following situations may display in the event of a power surge:

| Situation | Solution |
|--|--|
| The massage chair is connected to the power supply but is not functioning. | <ol style="list-style-type: none">1. Check to see that the plug is well connected and working.2. Make sure that the massage chair switch is turned to the "I" position. |
| The remote control works, but the massage chair is not functioning. | <p>The massage chair may have overheated due to prolonged use.</p> <p>Turn off the power and allow the chair to cool for 30-50 minutes.</p> |
| Both the remote control and the massage chair are not functioning. | <ol style="list-style-type: none">1. Make sure the chair is plugged into a working outlet.2. Turn the power OFF and then ON again. |

If you continue to have problems, please read the warranty card and contact the COZZIA service department.

10 Product Care and Storage

1. Storing the Massage Chair

- Wipe off dust and dirt from the massage chair with a dry, soft, clean cloth after use.
- Keep the massage chair clean and away from places of high humidity.
- If the massage chair is not to be used for a long period of time, cover the massage chair with a dust cover and unplug its power plug from the electrical outlet.



Caution

- Do not store the massage chair in direct sunlight or in places of high temperature. This may cause the color of the upholstery to fade.
- Do not allow the massage chair to remain in contact with vinyl or wallpaper for extended periods of time as this could lead to discoloration.

2. Cleaning the Massage Chair

- Before cleaning, ensure that the main power switch is off and the power plug is disconnected from the electrical outlet.
- Wipe off dust and dirt from the massage chair with a dry, soft, clean cloth after each use.
- This product can be cleaned thoroughly with a slightly damp cloth.
- Do not iron the upholstery.
- Do not wash the upholstery using a home washing machine as this may result in deterioration of the upholstery's quality.



Caution

- Do not use abrasive cleaning agents like benzene or thinner to clean the massage chair. This may cause the upholstery to fade.

3. Cleaning the Controller

- Use only a clean, dry cloth to clean the controller



Caution

- Do not use a wet cloth to clean the controller. This may result in malfunction.

11 COZZIA Consumer Warranty

COZZIA products have the following warranty: COZZIA's massage chairs, motion upholstery and home theater massage seating provide a one year in-home service warranty and a two-year parts warranty. COZZIA customer service will not issue Return Material Authorizations (RMAs) for products. COZZIA products will be either repaired by the consumer or by an in-home technician. COZZIA will not issue Return Material Authorizations (RMAs) for buyer's remorse.

SERVICE AND TECHNICAL SUPPORT

Consumers may contact COZZIA's customer service department at 1-877-977-0656 between 9:00 am and 5:00 pm PST, Monday through Friday or email us at Service@cozzia-usa.com or visit our web at www.cozzia-usa.com for warranty or service issues.

Consumers are required to provide the unit serial number and dated proof of purchase (sales receipt) when they contact the COZZIA service department regarding a repair.

A COZZIA customer service representative will attend to most consumer inquiries, but in some cases a technical service specialist will provide advanced support.

Non-warranty repair is provided on a "per incident" basis. COZZIA customer service will verify that the unit has failed and provide instructions for repairing a unit. All applicable repairs, parts, shipping, handling, local tax and a "per incident" fee will be charged for non-warranty repairs and support calls.

Proof of purchase (original receipt) is required for all warranty repairs or service.

EXTENDED WARRANTIES:

Cozzia offers extended warranty programs to enhance ownership of Cozzia product. Extended warranty provides: 3-year limited repair or replacement massage chair warranty with on-site service.

Please visit www.cozzia-usa.com for the latest terms and pricing for extended warranties.

PRODUCT REPAIRS

Many COZZIA product repairs may be performed by the consumer in their own home with parts and instructions supplied by COZZIA such as remote controller replacements that don't require a technician.

Canadian consumers may contact COZZIA's customer service department at **1-877-977-0656** between 9:00 am and 5:00 pm PST, Monday through Friday for warranty or service issues.

- **Floor Models and Demonstration Units** have a prorated warranty period that begins the day the model is placed on the floor and connected to an electrical outlet by the retail partner. Proof of purchase is required in order to obtain warranty service and parts. Non-warranty parts and service are available at a "per incident" charge.
- **Warranty Coverage Period** - Warranty coverage starts at the time that the consumer PURCHASES their chair. Proof of purchase is required for all warranty repairs. The warranty time period is measured by continuous calendar days based on a seven-day week.
- **Field Service** – COZZIA customer service department will diagnose and schedule an authorized service provider to repair the chair in the consumer's residence.
- **Parts** - All parts deemed necessary for repairs will be shipped to the consumer at no charge by the COZZIA service department.

CONSUMER WARRANTY LIMITATIONS AND EXCLUSIONS

- Warranties are only valid in the 48 contiguous United States and Canada and are contingent upon the consumer operating the chair according to the corresponding instruction manual.
- The warranty only applies to COZZIA products and does not include any accessories or enhancements.
- Field service requires pre-approval and must be performed by COZZIA's authorized field service personnel. Field service is only available in the United States and in major metropolitan areas in Canada.

-
- Softening of foams and filling composites in pillows, pads, and memory foam occurs naturally and does not constitute a defect under this warranty.
 - Fading, wear and piling of fabrics occurs naturally and does not constitute a defect under this warranty.
 - Natural markings, grain and dye variations in leather do not constitute a defect under this warranty.
 - Warranties do not cover any loss or damage resulting from improper installation, unauthorized repairs or modifications, improper use of electrical/power supply, loss of power, dropped product, a malfunction or damage of an operating part from failure to provide manufacturer's recommended maintenance, transportation damage, theft, abuse, misuse, neglect, vandalism or environmental conditions (fire, floods, rust, corrosion, sand, dirt, windstorm, hail, earthquake or exposure to weather conditions), loss of use during the period the product is at a repair facility, or otherwise awaiting parts or repair.
 - Damage due to shipping and handling does not constitute a defect under this warranty.
 - Under no circumstance shall COZZIA or its representatives be liable for indirect, consequential, or incidental damages (including damages for lost profits, business interruption, bodily injury, medical and the like), even if any party has been advised of the possibility of such damages.
 - Warranties are non-transferable and shall be in lieu of any other warranty, express or implied, including but not limited to any implied warranty or merchantability or fitness for particular use.
 - COZZIA's sole liability and the purchaser's exclusive remedy shall be for the repair, or at COZZIA's option, for the replacement of the defective part. Notwithstanding the above, if replacements parts for defective materials are not available, COZZIA reserves the right to make substitutions in lieu of repair or replacement.
 - **All warranties begin on the DATE OF PURCHASE; no allowance or extension is offered for delivery and/or installation.**
 - Warranties do not apply to rental, business, commercial, institutional or other non-residential users.

Warranty Card



WARRANTY REGISTRATION FORM

Product Serial No. (located on product): _____

Purchase Price: _____ Model No: _____

Date Purchased: _____

First Name: _____ Last Name: _____

Address: _____

City: _____ State: _____ Zip: _____

Phone: _____

Email: _____

Please mail to: Cozzia USA LLC
14327 E Don Julian Rd,
City of Industry, CA, 91746
Tel: 1-877-977-0656
Fax: 1-800-521-4712



